

MODEL - TRW212  
 CAPACITY - 2000LBS  
 WEIGHT - 275LBS  
 T & P - 8525LBS

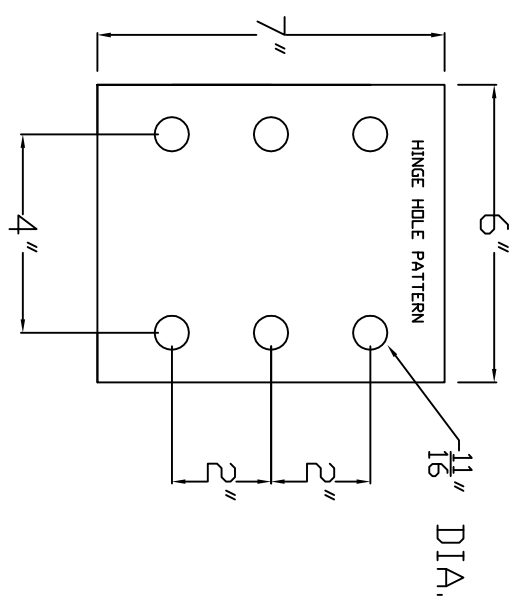

ADEQUACY OF MOUNTING SURFACE DETERMINED BY OTHERS. MOUNTING BOLTS NOT INCLUDED. USE GRADE 5 OR BETTER BOLTS. WEIGHTS ARE ESTIMATED.

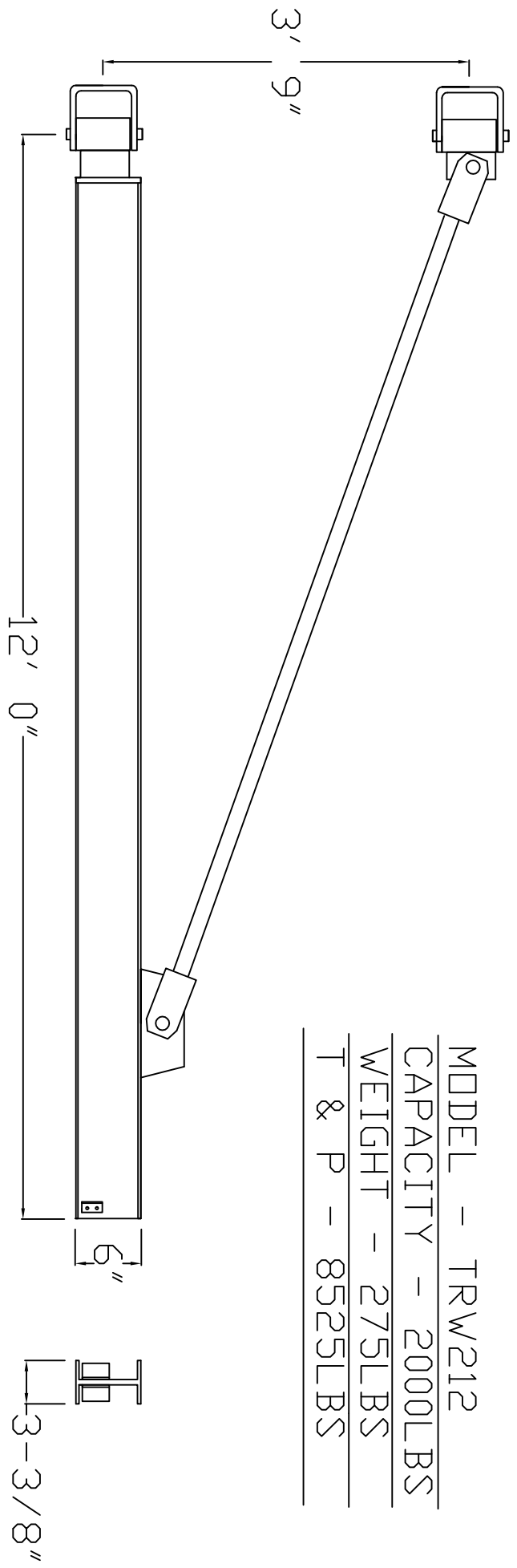

2127 W. NORDALE DR. APPLETON, WI 54914  
 PH - 920-380-0397 FAX - 920-380-0845